

Parts Breakdown

Item 19479

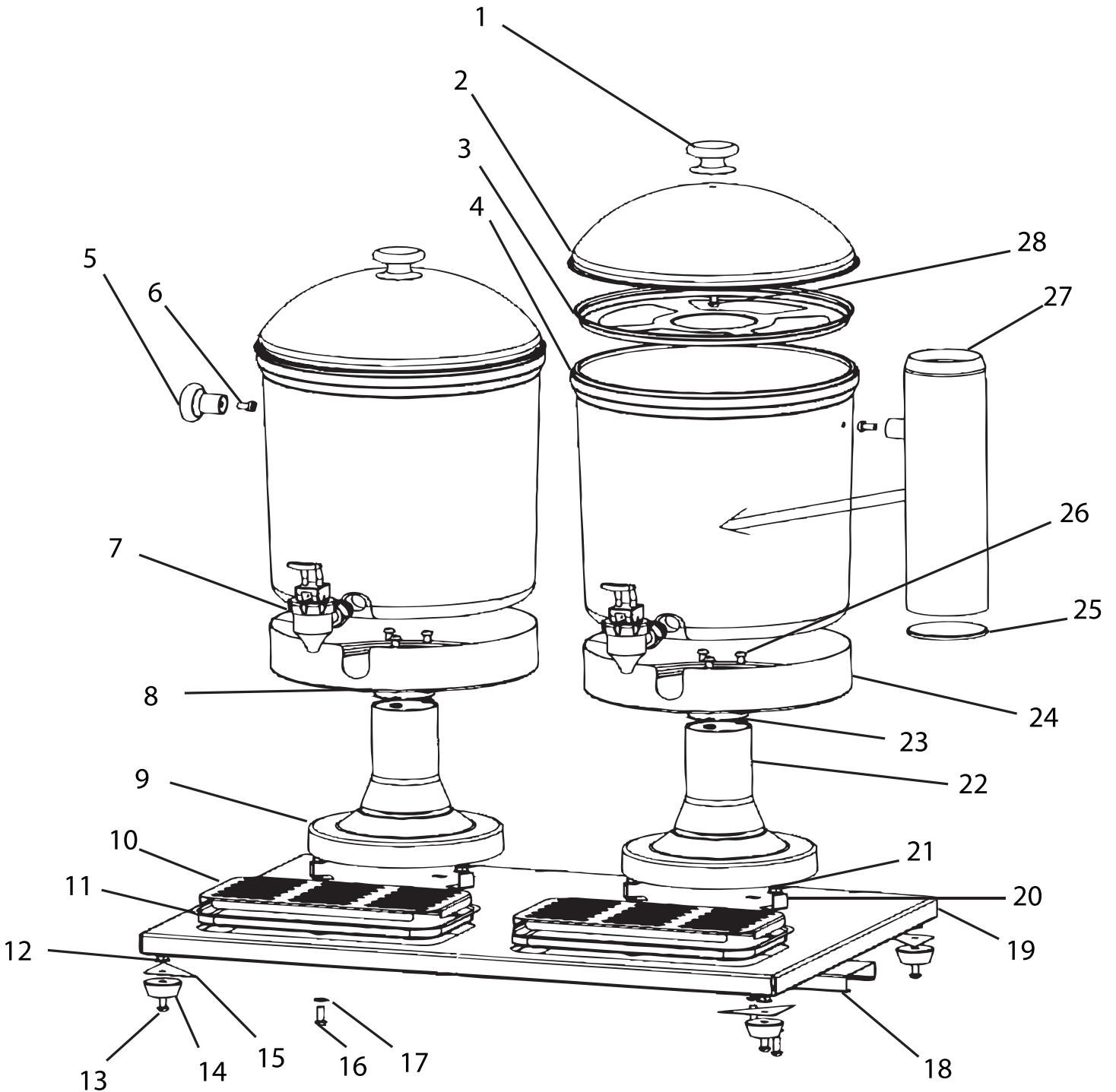

Parts Breakdown

Item 19479

Item No.	Description	Position	Item No.	Description	Position	Item No.	Description	Position
31472	Top Handlebar for 19479	1	77976	Holder Seat Assembly for 19479	9	77974	Flat for 19479	17
31473	Lid for 19479	2	31478	Net Seat for 19479	10	77977	Screw for Holder for 19479	23
31474	Net for 19479	3	31479	Water Seat for 19479	11	77978	Tray for 19479	24
31475	PC Body for 19479	4	77970	F-Screw for 19479	12	31480	Ice Pipe for 19479	25, 27
31476	Handlebar for 19479	5	77971	Nut for 19479	13	77979	Bolt-3 for 19479	26
31477	Small Screw for 19479	6	77972	Feet for 19479	14	77980	Bolt for 19479	28
27956	Tap for 19479	7	63541	Board Assembly for 19479	15 - 21	79581	Handle Seals for 19479	
77969	Small Cover for 19479	8	77973	Bolt-1 for 19479	16			